

SPECIFICATION SHEET

Fuel	Rating	kW	kVA
DIESEL	Intermittent	150.0	150.0
	Continuous	135	135
AMPERAGE	240 volt	625	
Ratings for Single Phase Unity PF 120/240 Volts			

Rating Definitions: Rated for 1800 rpm.

Intermittent - Applicable for a varying intermittent loads with no overload capability.
 Continuous - Continuous prime rating is applicable for supplying power to a varying load for an unlimited amount of running time, with 10% overload capacity available for 1 out of every 12 hours.

STANDARD FEATURES:

Tradewinds Power Corp agricultural generator sets are designed, packaged, and tested to meet the power requirements of a wide range of equipment used in agricultural applications. All our systems and components are prototyped, assembled and tested within a purpose built packaging, manufacturing, and test facility.

Key System Features are:

- Rugged industrial diesel engine
- EPA certified for Agricultural use
- Unit designed to fit through 48 inch door opening
- Assembled on integral sub-base with lifting eyes
- Self contained with mounted exhaust and air-cleaner
- Heavy duty exhaust muffler
- Analog control panel
- 15-feet of fuel feed and return rubber hose

Engine:

- Perkins 1106D-E70TAG3 diesel engine
- Heavy duty rated for continuous prime power operation
- Cooling system capable of operation at 120°F ambient
- The 1106D utilizes the latest diesel mechanical controlled fuel system technology. This allows the 1106D-E70TAG3 to deliver high power density and excellent fuel economy with low exhaust emissions and minimum heat rejection
- The 1106D has been designed to be worldwide fuel tolerant, and 5% bio-fuel (RME) options are available to meet local market needs
- Mounted air filter and turbocharger
- Wet cast iron sump with filler and dipstick

Alternator:

- Marathon 4-wire brushless generator
- Wound for high motor starting capability
- Single phase, 120/240 volt

Arrangement:

- Engine and generator close coupled together
- Self contained with mounted radiator, exhaust & controls

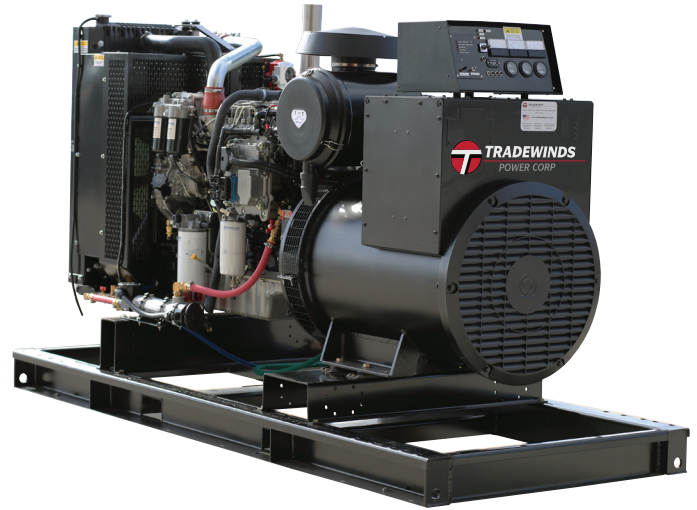

MODEL DEPICTED: TP175P

OPTIONAL ACCESSORIES:

- Above ground fuel tank
- Feed and return fuel lines
- Battery heater
- AC alternator strip heater
- Generator main line circuit breaker
- Thomson automatic transfer switch

AUTOMATIC ENGINE CONTROLLER:

- Automatic engine controller with analog display of all functions
- Manual emergency toggle switch override, to enable the set to be started quickly in the manual position in case of control panel failure
- Metering for AC voltmeter, AC frequency, percentage of load, and hour meter



ANALOG CONTROL PANEL

WARRANTY:

- Engine covered under the original equipment manufacturer's warranty - consult Tradewinds Power Corp for details
- Complete package supplied with 2-year unlimited warranty

The manufacture reserves the right to change the design or specifications without notice and without any obligation or liability whatsoever.

ENGINE SPECIFICATION:	
Manufacturer	Perkins
Model	1106D-E70TAG3
Emissions	EPA Tier 3
Engine speed (rpm)	1800
Nominal Engine hp 1800rpm	223
Cylinder arrangement	Vertical, in-line
Combustion system	Direct Injection
Aspiration	Turbocharged aftercooled
Engine type	Diesel
Diesel Fuel Grade	ASTM D975 D2
Number of Cylinders	4
Displacement in ³ (liters)	428 (7.01)
Bore and Stroke inches (mm)	4.13 x 5.31 (105 X 135)
Cooling	Water-cooled
Governor	Electronic
Starting aids	Glow Plugs
Compression ratio	16.8:1
Air cleaner type	Medium duty dry type
Exhaust Silencer dBA	80dBA
Fuel Filter	Full flow with water separator
COOLING SYSTEM FOR OPERATING AT 120° AMBIENT:	
Cooling System	Water-cooled
Engine Coolant Capacity gals (Liters)	5.5 (21.0)
Fan	Belt driven pusher fan
Radiator	Engine mounted
Coolant grade	TBA
LUBRICATING SYSTEM:	
Total lubricating capacity gals (Liter)	4.36 (16.5)
Recommended lubricating oil grade	SAE 15W40
Oil consumption at full load	< 0.1% of fuel consumption
Maximum Allowable Oil Temperature F (C)	250 (121)

ALTERNATOR:	
Configuration	Brushless, 4-wire
Frequency	60 Hz
Voltage regulation	+ or - 5%
Phase	Single
Coupling	Flexible half coupling
Bearing	Single
Manufacturer	Marathon
Model	TBA
Voltage Configuration	120/240
ARRANGEMENT:	
Coupling	Flexible half coupling
Assembly	Close coupled to flywheel flange
Base arrangement	Rigid steel base frame
Lifting capacity	4-lifting eyes
FUEL CONSUMPTION: GALS/HOUR (LITER/HOUR)	
Standby	12.13 (45.9)
Prime Power	11.17 (42.3)
75%	9.17 (34.7)
50%	6.29 (23.8)
25%	3.43 (13.0)
ENGINE ELECTRICAL SYSTEM:	
Starting motor voltage	12 volt
Charger	65 A Alternator with DC output
Wet Cell Battery	Lead Acid
ANALOG CONTROL PANEL:	
Analog controls	Auto/Stop/Run/Manual
Manual emergency run switch	Override toggle switch to start
Instrumentation	AC Voltmeter
	AC Frequency Meter
	Percentage of Load
	Hour Meter

KEY DIMENSIONS AND WEIGHT		
Description	Key	Inches
Height	H	61.58
Length	L	106.50
Width	W	44.00
Dry Weight lbs (Kg)		3676 (1671)

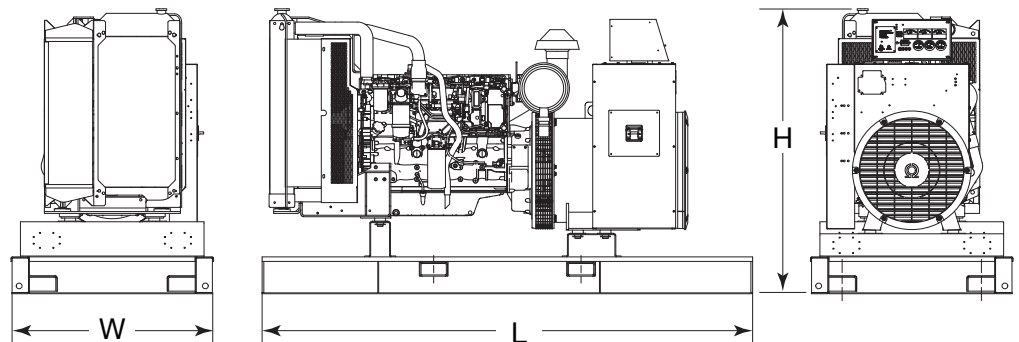
**ARRANGEMENT DRAWING MODEL:
TP150P**

TRADEWINDS POWER CORP
 5820 NW 84th Ave
 Miami, FL 33166
 Office: (800) 223-3289